

PRODUCT GUIDE

2024



Promotrader are proud partners of ShopGlenEira.com.au

- 1300 211 995
- www.promotrader.com.au
- hello@promotrader.com.au

A-Frames	20
Aluminium Composite Panel (Dibond) Signs	10
Arch Banners	3
Backlit Poster Frames	30
Backpack Tear Drop & Wing Banners	3
Bases & Accessories	4
Bollard and Light Pole Covers (Corflute)	10
Bunting	18
Café Barriers	11
Café Umbrellas (for events)	13
Camping Canopy	18
Car Flags	15
Car Magnets	15
Corflute Signs	10
Crowd Barriers	29
Directional Signs	12
Exhibition Booths	26
Fence Mesh	16
Flag Pole Flags	14
Flat Panel Signs	9
Floor Stickers	22
Hand Sanitiser Dispensing Stations	22
Hand Wave Flags	14
Hanging Corflute Squares	29
Illuminated / LED Signage	12
Inflatables	31
Light Boxes	30
Marquees	17
Media Walls	23
Mesh Polyester Banners	11
Music Stand Covers	15
Pennants	15
Plastic Cards & Accessories	33
Polyester Sleeve Floor Displays	25
Pop Up Banners	19
Promotion Tables	28
Pull Out Banners	13
Pull Up Banners	5
Retail Mesh Banners	11
Sampling Tables	29
Shop Front Flags	14
Signage Barriers	8
Signage Stands	7
Snap Lock Picture Frames	12
Stretch Fabric Arches	25
Stretch Fabric Displays	24
Table Covers	27
Table Top Banners	6
Tear Drop and Wing Banners	3
Tear Drop and Wing Banner Shapes / Sizes	2
Vinyl Mesh and Vinyl Banners	16
X-Banners	6

Tear Drop Banner

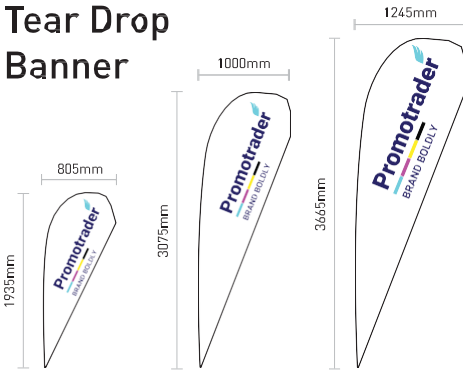

Wing Banner Shape 1

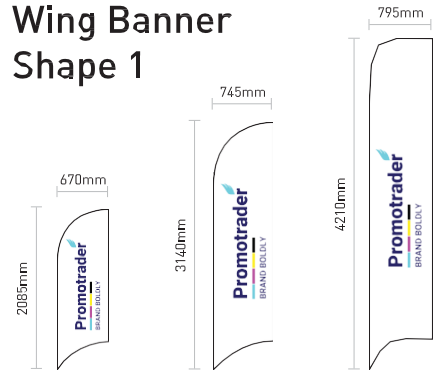

Wing Banner Shape 2

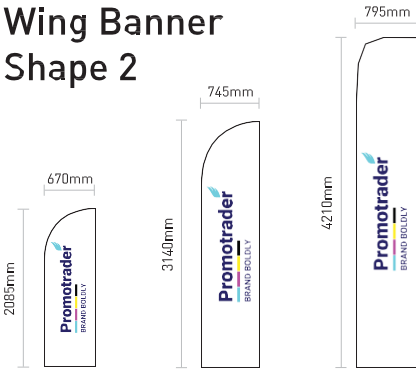

Wing Banner Shape 3

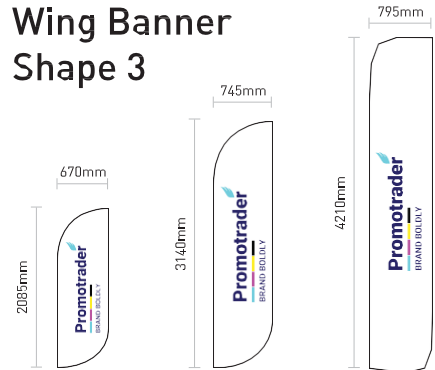

Wing Banner Shape 4

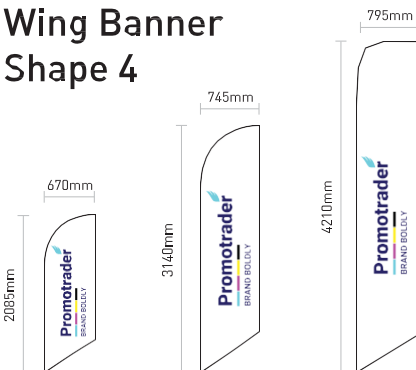

Wing Banner Shape 5

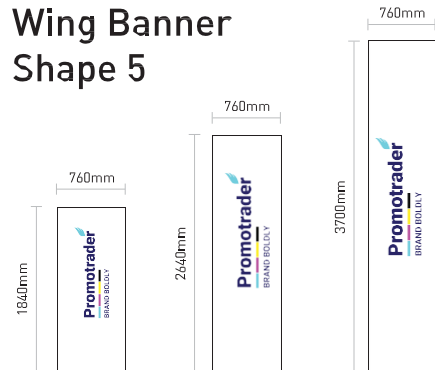

- Total set up height from ground dependent on pole size and base type
- Banners are supplied in an Oxford carry case and include pole kit and selected base type
- Banner sleeve pockets are black (or white if requested).





Tear Drop and Wing Banners

Supplied with base of choice

- Free artwork set up
- Banner shapes and sizes are on page 2
- Banners are supplied with an Oxford carry case and base of choice
- Banner poles are fibreglass
- Eco-Friendly recycled material manufactured to Global Recycled Standard 4.0 (GRS 4.0) and printed with Eco-Friendly inks
- Banners are printed UV resistant full colour dye sublimation, banner sleeve pockets are black (or white if requested)
- Single sided banners are printed on 110gsm knitted polyester
- Double sided banners are printed on 2 pieces of 110gsm knitted polyester with a UV block-out sheet in-between to prevent the image on the other side of the banner showing through
- Standard lead time 10 - 15 days from artwork approval for orders up to 19 banners. Please contact us for lead time for orders of 20 or more banners

Arch Banners

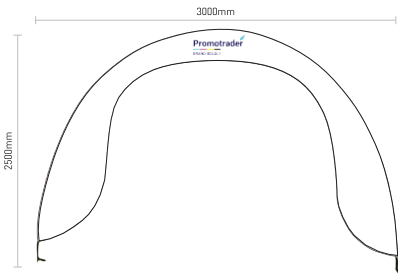

Backpack Tear Drop and Wing Banners



- Banner shapes and sizes:
 - Tear Drop (665mm x 1310mm)
 - Wing Banner (500mm x 1400mm)

Supplied with backpack

Bases / Accessories



Water Bag
(optional extra)

Retractable Cross Base

- Weight - 3kg
- Chrome plated
- Great for installing wing and tear drop banners indoors or outdoors with a water bag



Water Base

- Weight - approx. 18kg when filled
- Available in black only
- Perfect for installing wing and tear drop banners in windy areas



Car Base

- Weight - 3kg
- Suitable for installing banners next to a vehicle as the car wheel holds the base in place



Screw In Base / Spiky Base

- Light weight
- Excellent for installing wing and tear drop banners on lawn or other soft surfaces. Screw In Base can be left in ground permanently

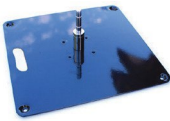

Water Bag
(optional extra)

Flat Metal Base

- Weight - 5kg
- Black powder coat with chrome spindle
- Great for installing wing and tear drop banners indoors or outdoors with a water bag



Wall / Ground Mount Brackets

- Allows the banner to be installed off of the ground for increased height and visibility
- Available in 25 and 180 degree and ground mount bracket
- For use with SMALL and MEDIUM banners only



Water Bag
(optional extra)

Steel / Light Weight Swivel Base

- Steel - 4kg / Light Weight - 1.5kg
- Swivel feet for easy storage
- Great for installing outdoors with water bag or secure to ground with pegs (pegs not included)



Marquee Water Base

- Weighs approx. 9kg when filled



Marquee Weight

- Weighs 5kg



Umbrella Water Base

- Weighs approx. 23kg when filled

Diameter of spindle on all bases is 15mm

Pull Up Banners

- Free artwork set up
- Ideal for trade shows, showrooms, reception areas, displays, conferences, presentations etc.
- Quick set up and compact storage
- Full colour digital print on curl resistant Rite-Flat blockout media
- Budget Pull Up Banner supplied with silver aluminium base with fold out feet and black plastic end and feet caps (approx. 2.5kg)
- Light Weight Pull Up Banner supplied with silver aluminium base with fold out feet (approx. 3kg)
- Premium Pull Up Banner supplied with silver streamline weighted base (approx. 6kg)
- Eco-Friendly option available - supplied with bamboo base and fittings and printed on 540gsm PVC-Free PP/PE Hybrid media (approx. 3.5kgs) – refer to the Eco-Friendly section for more information
- Mini Pull Up Banner with modular height adjustable system
- Supplied with padded carry bag
- Standard lead time for quantities up to 4 is 2 – 3 days from artwork approval. Please contact us for lead time for orders of 5 or more banners



- Size options:
 - 400mm x 600mm – 1600mm (available in Mini, single sided)
 - 600mm x 1800mm (available in Light Weight & Premium, single sided)
 - 800mm x 2000mm (available in Bamboo, single sided)
 - 850mm x 2000mm (available in Budget, single sided)
 - 850mm x 2100mm (available in Light Weight & Premium, single sided or double sided)
 - 1000mm x 2100mm (available in Light Weight single sided & Premium single or double sided)
 - 1200mm x 2200mm (available in Light Weight single sided & Premium single or double sided)

Table Top Pull Up Banners

- Free artwork set up
- Silver aluminium light weight base available in A3 & A4
- Full colour single or double sided digital print on curl resistant polypropylene
- Ideal for trade shows, presentations, displays, conferences, etc.
- Standard lead time for quantities up to 4 is 2 – 3 days from artwork approval. Please contact us for lead time for orders of 5 or more banners



Table Top Tear Drop Banners

- Free artwork set up
- Full colour dye sublimation print on 110gsm knitted polyester
- 580mm tall, weight 0.3kg
- Single sided only (reverse image on back)
- Print can be different on each banner eg. different numbers for table settings
- Supplied with fibreglass pole and metal base
- Replacement skins available
- Standard lead time 10 - 15 days from artwork approval



X-Banners

- Free artwork set up
- Full colour digital print on matte polypropylene
- Print size 600mm x 1600mm
- Single sided only
- Supplied with light weight fibreglass frame and carry bag
- Eco-Friendly option available - supplied with bamboo base and fittings and printed on 540gsm PVC-Free PP/PE Hybrid media – refer to the Eco-Friendly section for more information
- Standard lead time for quantities up to 4 is 2 – 3 days from artwork approval. Please contact us for lead time for orders of 5 or more banners



Signage Stands

Vinyl Banner Stands

- Free artwork set up
- Ideal for trade shows, exhibitions, sporting events etc.
- Full colour digital print on 440gsm gloss vinyl or 360gsm vinyl mesh
- Suitable for single or double sided displays
- Quick set up and compact storage
- Light weight aluminium frame
- Frame size:
 - 2150mm x 1000mm
- Banner size:
 - 2000mm x 850mm
- Graphics are secured to the frame with elastic bungee style cords
- Packs flat for easy transportation
- Supplied with carry bag
- Standard lead time for quantities up to 4 is 2 – 3 days from artwork approval. Please contact us for lead time for orders of 5 or more



Graphic Panel Stakes

- Free artwork set up
- Suitable for soft ground outdoor surfaces
- Strong 5mm black powder coated wire frame with handle
- Quick set up and easy storage
- Corflute panel can be changed as required
- Available with single sided or double sided full colour print on SAV
- Size:
 - 600mm x 900mm (total height 1050mm)
- Standard lead time for quantities up to 4 is 3 - 5 days from artwork approval. Please contact us for lead time for orders of 5 or more

Wire Stakes

- Free artwork set up
- Strong 5mm wire to prevent stakes bending when inserting into the ground
- Corflute panel size: 600mm x 450mm
- Standard lead time for quantities up to 4 is 2 – 3 days from artwork approval. Please contact us for lead time for orders of 5 or more



Breeze Panel Signs

- Free artwork set up
- Great for shopping malls, pavements etc.
- Easy to assemble, light weight, no tools required
- Metal panel with black metal frame and plastic water fillable base for stability
- Full colour digital print on SAV
- Graphic size: 588mm x 917mm
- Tilt and move – wheels included
- Optional header board available
- Standard lead time 3 – 5 days from artwork approval



Swing Spring Signs

- Free artwork set up
- Great for trade shows, exhibitions, shopping malls, pavements etc.
- Easy to assemble, light weight, no tools required
- Plastic stand with water fillable base including wheels and moulded handle for easy movement
- 3mm corflute panels, both sides
- Full colour digital print on SAV
- Graphic size: 420mm x 600mm
- Standard lead time 3 – 5 days from artwork approval

Signage Barriers

- Free artwork set up
- Freestanding barrier style sign
- Water fillable polyethylene bases (2 x 25 litre tanks)
- Powder coated aluminium rods to hold print media
- Single sided or double sided print to Corflute or Aluminium Composite Panel
- Size options:
 - 2000mm x 1200mm (weighs 64.5kgs when filled)
 - 3000mm x 1200mm (weighs 67.5kgs when filled)
- Standard lead time 4 – 5 days from artwork approval



PVC Stands

- Free artwork set up
- Full colour double sided digital print on SAV
- Stand size:
 - 500mm diameter
- Recommended panel size:
 - Corflute 460mm x 900mm
 - Aluminium Composite Panel (Dibond) 460mm x 1200mm
 - Custom sizes available
- Suitable for indoor or outdoor use
- Rounded corners & smooth edges on print panel minimise health & safety concerns
- Large visual area for maximum impact
- Rugged recycled PVC base for excellent stability
- Single nylon fixing - no tools required
- Base includes carry handle
- Standard lead time for quantities up to 4 is 3 - 5 days from artwork approval.
Please contact us for lead time for orders of 5 or more



Metal Stands

- Free artwork set up
- Full colour double sided digital print on SAV
- Stand size:
 - 400mm x 300mm x 90mm
- Recommended panel size:
 - Corflute 450mm x 900mm
 - Aluminium Composite Panel (Dibond) 450mm x 1200mm
 - Custom sizes available
- Black powder coated metal stand holds a panel of up to 25mm thickness
- Suitable for indoor or outdoor use
- Rounded corners & smooth edges on print panel minimise health & safety concerns
- Large visual area for maximum impact
- Designed for use with a wide variety of substrates
- Standard lead time for quantities up to 4 is 3 - 5 days from artwork approval.
Please contact us for lead time for orders of 5 or more



Flat Panel Signs

- Free artwork set up
- Ideal for a variety of outdoor uses
- Powder coated 50mm square steel tube frame available in black or white
- Aluminium Composite Panels (Dibond) used for the print area
- Full colour single or double sided print on SAV with laminate for added durability
- Large visual area for maximum impact
- Very easy to install – quick installation with star droppers (not included)
- Sizes:
 - 600mm x 900mm (total height 1500mm)
 - 900mm x 1200mm (total height 1800mm)
 - 1200mm x 1800mm (total height 2000mm)
- Standard lead time for quantities up to 4 is 3 - 5 days from artwork approval.
Please contact us for lead time for orders of 5 or more



Aluminium Composite Panel (Dibond) Signs

- Free artwork set up
- Very durable - 3mm thickness
- Full colour SAV digital print with laminate for extra durability, single or double sided
- Suitable for indoor or outdoor use
- Custom sizes available
- Standard lead time for quantities up to 4 is 2 – 3 day from artwork approval. Please contact us for lead time for orders of 5 or more



CUSTOM SIZES AVAILABLE

Corflute Signs

- Free artwork set up
- 3mm or 5mm thickness
- Full colour digital print, single or double sided
- Suitable for indoor or outdoor use
- Custom sizes available
- Standard lead time for quantities up to 4 is 2 – 3 days from artwork approval. Please contact us for lead time for orders of 5 or more

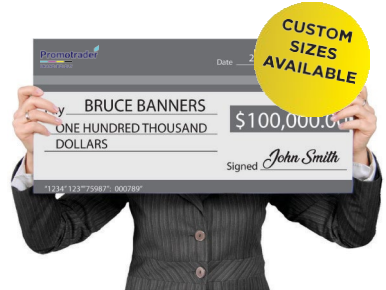

CUSTOM SIZES AVAILABLE



CUSTOM SIZES AVAILABLE

Bollard and Light Pole Covers (Corflute)

- Free artwork set up
- Full colour digital print on SAV
- Bollard cover size 270mm x 1000mm x 3mm corflute
- Light pole cover size 500mm x 1500mm x 3mm corflute
- Standard lead time for quantities up to 4 is 2 – 3 days from artwork approval. Please contact us for lead time for orders of 5 or more



Mesh Polyester Banners

- Free artwork set up
- Eco-Friendly recycled material manufactured to Global Recycled Standard 4.0 (GRS 4.0) and printed with Eco-Friendly inks
- Full colour dye sublimation print
- 130gsm polyester mesh fabric
- Banners are supplied with reinforced edges and eyelets every 1000mm
- Standard lead time 10 - 15 days from artwork approval



Retail Mesh Banners

- Free artwork set up
- Eco-Friendly recycled material manufactured to Global Recycled Standard 4.0 (GRS 4.0) and printed with Eco-Friendly inks
- Single sided or double sided print available
- Full colour dye sublimation on 100D polyester (other fabrics available)
- Supplied with aluminium snap lock frame with hooks top and bottom
- Any size available (up to 1500mm wide if aluminium snap lock frame required)
- Standard lead time 10 – 15 days from artwork approval

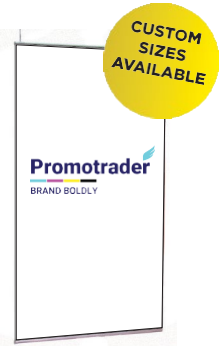

- Free artwork set up
- Great for use in café/restaurant alfresco areas or for other barrier uses
- Frame is supplied flat packed and simply clicks together
- Light weight aluminium tube frame with feet (43mm diameter frame)
- Full colour double sided dye sublimation on 230gsm polyester
- Size options:
 - 1040mm x 915mm (graphic area 900mm x 710mm, plus 65mm blackouter sleeve)
 - 2040mm x 915mm (graphic area 1900mm x 710mm, plus 65mm black outer sleeve)
- Standard lead time 10 – 15 days from artwork approval

Directional Signs

- Free artwork set up
- Suitable for interior use only
- Great for directional signage in shopping malls, exhibition halls, offices, airports etc.
- Hanging ceiling signs are double sided, can have 1 or 2 sign panels, include an anti-reflection cover and are supplied with a hanging kit
- Wall signs are single sided, include an anti-reflection cover and attach to the wall with double sided tape
- Various sizes available
- Standard lead time for quantities up to 4 is 3 - 5 days from artwork approval. Please contact us for lead time for orders of 5 or more



Illuminated / LED Signage

- Free artwork set up
- Several different LED configurations available – edge lit, front lit, back lit, neon etc.
- Any LED colour effect available
- Custom shapes and sizes available
- Please contact us for lead times



Snap Lock Picture Frames

- Free artwork set up
- Size options:
 - A4 print size
 - A3 print size
 - A2 print size
 - A1 print size
- 25mm rounded snap lock frame
- Supplied with full colour digital print (can supply frame only or print only)
- Replacement prints available
- Standard lead time for quantities up to 4 is 2 – 3 days from artwork approval. Please contact us for lead time for orders of 5 or more



Café Umbrellas (for events)

- Free artwork set up
- Great for shade at events and functions
- Standard and heavy duty options available
- Several print options available
- Dye Sublimated options use Eco-Friendly recycled material manufactured to Global Recycled Standard 4.0 (GRS 4.0) and are printed with Eco-Friendly inks
- Available with or without a valance
- Canopies available individually



STANDARD UMBRELLAS

Option 1

- 2.5m x 2.5m (6 panel) canopy
- Dark grey powder coated 38mm diameter aluminium pole with pulley system
- Print Options*:
 - Dye sublimation on waterproof, PU coated and flame retardant 500D Oxford fabric canopy
 - Screen print, digital print or heat transfer on 180gsm Spun Polyester canopy
- Please contact us for lead times

Option 2

- 3.0m x 3.0m (8 panel) canopy
- Dark grey powder coated 38mm diameter aluminium pole with pulley system
- Print Options*:
 - Dye sublimation on waterproof, PU coated and flame retardant 500D Oxford fabric canopy
 - Screen print, digital print or heat transfer on 180gsm Spun Polyester canopy
- Please contact us for lead times

HEAVY DUTY UMBRELLAS

Option 1

- 2m x 2m square canopy (4 panel)
- 47mm diameter aluminium pole
- Print Options*:
 - Dye sublimation on waterproof, PU coated and flame retardant 500D Oxford fabric canopy
- Standard lead time is 10-15 days from artwork approval

Option 2

- 4m x 4m (8 panel) canopy
- Dark grey powder coated 67mm diameter aluminium pole with deluxe crank open/close system
- Print Options*:
 - Screen print, digital print or heat transfer on 230gsm Spun Polyester canopy
- Please contact us for lead times

Pull Out Banners

- Set up fee applies
- Size of opened banner is 700mm x 240mm
- Double sided or single sided print available
- Offset gravure print
- Please contact us for lead times



Flag Pole Flags

- Free artwork set up
- Flags include sister clips for easy installation - optional fittings available
- Eco-Friendly recycled material manufactured to Global Recycled Standard 4.0 (GRS 4.0) and printed with Eco-Friendly inks
- Flags are dye sublimated on 110gsm knitted polyester (approx. 90% bleed through) or 130gsm trilobal polyester (approx. 75% bleed through) with double stitched edges
- Standard sizes:
 - 1800mm x 900mm
 - 2500mm x 1250mm
 - 2500mm x 1250mm
- Double sided flags available
- 500D woven polyester available for extra durability and longer life
- Standard lead time 10 - 15 days from artwork approval for orders up to 49 flags. Please contact us for lead time for orders of 50 or more flags



Sister Clip

Shop Front Flags

- Free artwork set up
- Full colour digital print on 400gsm double sided vinyl or 500D double sided Oxford fabric
- Flag size 400mm x 600mm
- Supplied with removable plastic pole and 4 way bracket to allow set up at various angles
- Standard lead time 10 - 15 days from artwork approval



Hand Wave Flags

- Free artwork set up
- Standard flag size:
 - 300mm x 200mm
 - Custom sizes available
- Available in:
 - PVC : Double sided print on 0.2mm PVC
 - Polyester : Single sided print (100D polyester with approx. 85% bleed through)
 - Paper : Single or double sided print on coated paper
 - PPE Clear Plastic : Single sided print (with bleed through)
- Supplied with plastic pole
- Please contact us for lead times



Car Flags

- Free artwork set up
- Flag size is 450mm x 300mm
- Full colour single sided digital print on 110gsm knitted polyester
- Supplied with plastic pole and car window clip
- Please contact us for lead times



Car Magnets

- Free artwork set up
- Full colour digital print on 0.9mm thick magnet
- Ideal signage for cars, vans, trucks etc.
- Recommended magnet size of 600mm x 300mm for best adhesion to vehicle
- Standard lead time for quantities up to 4 is 2 – 3 days from artwork approval. Please contact us for lead time for orders of 5 or more



Music Stand Covers

- Free artwork set up
- Full colour digital print on 160gsm satin drill
- Standard size:
 - 540mm wide x 530mm high, plus 200mm sleeve to slide over music stand
 - Custom sizes available
- Standard lead time 10 – 15 days from artwork approval



Pennants

- Free artwork set up
- Full colour digital print on 160gsm satin drill
- Includes 360mm cord on 235mm wide pole
- Standard size:
 - 210mm x 300mm with 20mm tassels
 - Custom sizes available
- Standard lead time 10 – 15 days from artwork approval



Fence Mesh (Polyester or PVC)

- Free artwork set up
- Full colour print
- Supplied with hemmed edges and eyelets
- Please contact us for lead times

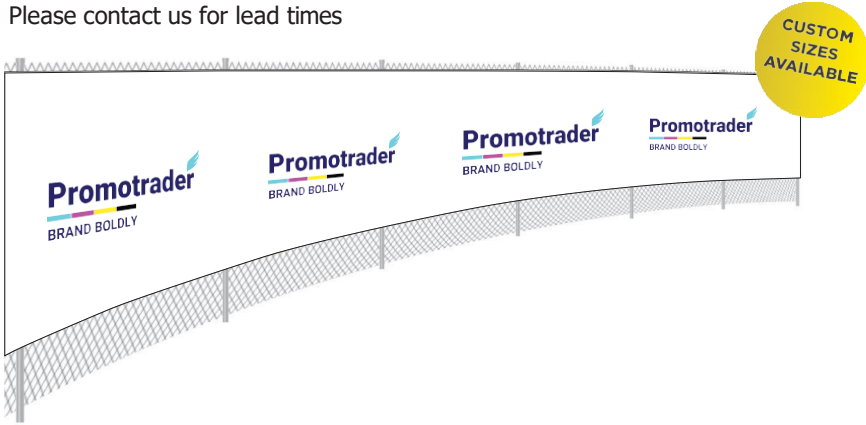

Vinyl Mesh and Vinyl Banners

- Free artwork set up
- Full colour CMYK digital print
- Single sided and double sided vinyl banners printed on outdoor quality vinyl (single sided only for vinyl mesh)
- Banners are supplied with welded edges and eyelets every 1000mm
- Standard lead time for quantities up to 4 (based on single sided and maximum height of 1500mm) is 2 – 3 days from artwork approval. Please contact us for lead time for orders of 5 or more banners, or banners that are double sided and/or larger than 1500mm along both height and width



Marquees

- Free artwork set up
- Supplied with 40mm aluminium frame, printed canopy, ropes, pegs and wheel bag
- Canopy is 500D Oxford fabric which is waterproof, PU coated and flame retardant
- Canopies available in Eco-Friendly recycled material manufactured to Global Recycled Standard 4.0 (GRS 4.0) and printed with Eco-Friendly inks
- Single sided or double sided full walls available for all sizes (half walls available for 3 metre sides only)
- Single sided walls available with window
- Clear protective screen walls available for 3 metre sides
- Full colour dye sublimation
- Size options:
 - 3m x 3m
 - 4.5m x 3m
 - 6m x 3m
- Replacement ropes and pegs available
- Frames and printed or unprinted walls and canopies available individually*
- Please contact us for lead times

Marquee Extras



Bracket for
Wing / Tear
Drop Banner

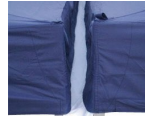

Gutter Kit
Gutter kit required
when joining 2
marquees



Sand Bag



Marquee Water Base
Weighs approx. 9kg when
filled



Marquee Weight
Weighs 5kg



*Un-printed stock walls and canopies available in black, red, yellow, green, blue and white

Camping Canopy



**Suitable for event use - if exposed to the weather permanently, fading will occur. Replacement canopies are available.*

- Free artwork set up
- Eco-Friendly recycled material manufactured to Global Recycled Standard 4.0 (GRS 4.0) and printed with Eco-Friendly inks
- Full colour dye sublimation single sided print*
- Supplied with 33mm aluminium poles (2400mm high), printed canopy, ropes and pegs.
- Canopy is 500D Oxford fabric which is waterproof, PU coated and flame retardant
- Replacement ropes and pegs available
- Size & shape options:
 - 4.5m x 4.5m (available in 4 or 6 angle shape)
 - 5.4m x 5.1m (available in 8 angle shape)
- Please contact us for lead times

Bunting

- Free artwork set up
- Vinyl or polyester - single sided or double sided
- Recycled polyester and block-out available
- 30 flags per 10 metres as a standard - customisation available
- Standard sizes:
 - Triangle flags, 150mm x 200mm
 - Rectangle flags, 150mm x 200mm
 - Custom sizes available
- PVC also available - minimum order 2000 metres
- Please contact us for lead times

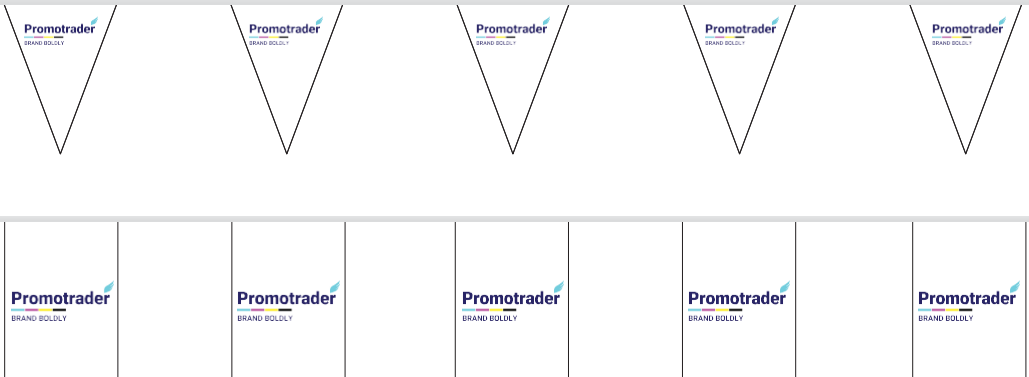
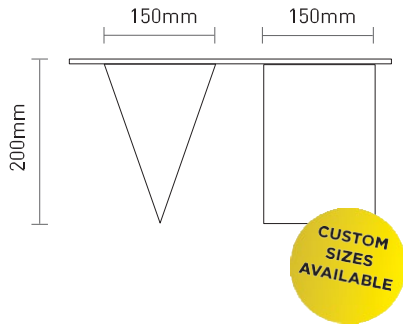

Pop Up Banners

- Free artwork set up
- Eco-Friendly recycled material manufactured to Global Recycled Standard 4.0 (GRS 4.0) and printed with Eco-Friendly inks
- Full colour dye sublimation print on 250gsm knitted polyester
- All sides can be printed
- Supplied with steel wire frame and carry case
- Standard lead time 10 - 15 days from artwork approval for orders up to 24 banners. Please contact us for lead time for orders of 25 or more banners



Round Pop Up Banners

- Size options:
 - 1200mm diameter
 - 1400mm diameter



Horizontal Pop Up Banners

- Size options:
 - 1300mm x 660mm
 - 1600mm x 650mm
 - 2000mm x 1000mm



Target hole can be included

Vertical Pop Up Banners

- Size options:
 - 920mm x 1100mm
 - 1050mm x 1250mm



Three Sided Vertical Pop Up Banners

- Size option:
 - 920mm x 1100mm

A-Frames

Premium Plastic A-Frames

- Free artwork set up
- Unique hinge design - strong and robust
- User friendly handle
- Aerodynamic for best wind resistance
- 600mm x 450mm signage face
- Double sided
- Optional header clip and corflute header board available separately
- Weight: 5kg
- Standard lead time for quantities up to 4 is 3 - 5 days from artwork approval. Please contact us for lead time for orders of 5 or more



Snap Lock A-Frames

- Free artwork set up
- Aluminium Snap Lock frame
- Full colour digital print (replacement prints available)
- Print size 594mm x 841mm
- Double sided
- Standard lead time for quantities up to 4 is 2 – 3 days from artwork approval. Please contact us for lead time for orders of 5 or more



Metal A-Frames

- Free artwork set up
- Great for trade shows, presentations, shopping malls etc.
- Metal frame with handle
- Metal panel on both sides
- Full colour digital print on SAV
- Large visual area for maximum impact
- Sizes:
 - 600mm x 450mm (6.0kg)
 - 600mm x 600mm (7.0kg)
 - 600mm x 900mm (9.0kg)
 - 900mm x 1200mm (12.0kg)
- Wheels available as an optional extra
- Standard lead time for quantities up to 4 is 2 – 3 days from artwork approval. Please contact us for lead time for orders of 5 or more



Corflute Insert A-Frames

- Free artwork set up
- Great for trade shows, presentations, shopping malls etc.
- 5mm corflute inserts, both sides
- Full colour digital print on SAV (replacement prints available)
- Metal frame
- Large visual area for maximum impact
- Sizes:
 - 600mm x 900mm (9.0kg)
 - 900mm x 1200mm (12.0kg)
 - 1200mm x 1800mm (16.5kg)
- Standard lead time for quantities up to 4 is 2 – 3 days from artwork approval. Please contact us for lead time for orders of 5 or more



Magnetic Chalk Board A-Frames

- Free artwork set up
- Great for applications where the message needs to be changed regularly
- Solid beechwood timber frame
- Aluminium composite panel backing includes chalk board option with magnetic properties
- Double sided full colour digital print on SAV
- Sizes:
 - 590mm x 780mm
 - 600mm x 1200mm
- Standard lead time for quantities up to 4 is 2 – 3 days from artwork approval. Please contact us for lead time for orders of 5 or more

Hand Sanitiser Dispensing Stations



- Free artwork set up
- Full colour double sided digital print on SAV
- Black powder coated metal stand and Melamine board
- Suitable for indoor use
- Easy tool-free assembly
- Portable freestanding design, ideal for high-traffic areas
- Dispenser bottle capacity is 1000ml (sanitiser not included)
- Standard size:
 - Stand 400mm x 300mm x 90mm
 - Panel 450mm x 1200mm
- Weight is 8.5kg
- Battery powered (4 x 1.5v C size batteries included)
- Other hand sanitiser station styles available on request
- Standard lead time for quantities up to 4 is 2 – 3 days from artwork approval. Please contact us for lead time for orders of 5 or more

Floor Stickers

- Free artwork set up
- Floor stickers are a perfect advertising medium for floors, walls and footpaths
- Premium quality, offering long durability due to the composition of PVC and fabric
- Embossed textured matte finish to prevent slippage - R11 slip rating (Slip Resistance Test AS 4586:2031)
- Lifespan of the stickers is dependent on the movement at the place of installation, however, is estimated to be approximately 9 to 12 months in normal operation
- Full colour digital print and cut to custom sizes
- Stickers can be removed without leaving residue behind
- Standard lead time 3 – 5 days from artwork approval



Media Walls

Fixed Size Media Walls

- Free artwork set up
- Great for trade shows, exhibitions, presentations, green screens, etc.
- Eco-Friendly recycled material manufactured to Global Recycled Standard 4.0 (GRS 4.0) and printed with Eco-Friendly inks
- Dye sublimation print on high quality 250gsm knitted polyester
- Wrap around printed sides available
- Graphics are attached to the aluminium concertina style frame with Velcro
- Size options:
 - 2250mm x 2250mm (flat or curved wall)
 - 3000mm x 2250mm (flat or curved wall)
- Set up and pull down in minutes
- Total weight of frame and print approx. 10kg
- Supplied with carry bag
- Standard lead time 10 - 15 days from artwork approval



Adjustable Media Walls

- Free artwork set up
- Dye sublimation print on high quality 250gsm knitted polyester or full colour digital print on 440gsm vinyl
- Ideal for trade shows, exhibitions, presentations etc.
- Quick set up and compact storage
- Light weight telescopic frame
- Adjustable size options (knitted polyester):
 - Height: 1070mm - 2470mm
 - Width: 1470mm - 3150mm
- Adjustable size options (vinyl):
 - Height: 1070mm - 2470mm
 - Width: 1470mm - 1500mm (or to 3150mm if height is no more than 1500mm)
- Supplied with carry bag
- Standard lead time with polyester banner is 10 - 15 days from artwork approval. Standard lead time with vinyl banner is 2 - 3 days from artwork approval for quantities up to 4. Please contact us for lead times for orders of 5 or more



Stretch Fabric Displays



Straight shape



U-shape



* All stretch displays supplied with carry bag



H-shape (flat, angled or curved top)



Snake shape



Rectangular shape



Triangular shape

- Free artwork set up
- Great for trade shows, presentations, displays, back drops etc.
- Light weight aluminium frame and feet (tube frame 1mm thick and 32mm diameter)
- Frame clicks together for quick and easy assembly and dismantle
- Eco-Friendly recycled material manufactured to Global Recycled Standard 4.0 (GRS 4.0) and printed with Eco-Friendly inks
- Full colour dye sublimation print to all sides on 250gsm stretch polyester sleeve (Snake and U-shape displays available as single sided print only)
- Size and shape options:
 - Straight shape (2950mm x 2210mm or 5940mm x 2210mm)
 - H-shape (flat, angled or curved top, 1000mm x 2500mm)
 - U-shape (single sided print only 3000mm x 2280mm)
 - Snake shape (single sided print only 915mm x 2280mm)
 - Rectangular shape (500mm x 700mm x 2000mm)
 - Triangular shape (710mm x 1270mm x 2430mm)
- Supplied with carry bag
- Standard lead time 10 – 15 days from artwork approval

Polyester Sleeve Floor Displays

- Free artwork set up
- Great for trade shows, presentations, back drops etc.
- Light weight aluminium frame with plastic foldable feet (suitable for indoor use)
- Frame clicks together for quick and easy assembly and dismantle
- Eco-Friendly recycled material manufactured to Global Recycled Standard 4.0 (GRS 4.0) and printed with Eco-Friendly inks
- Full colour double sided polyester pillow case style sleeve
- Size options:
 - 850mm x 2000mm
 - 1000mm x 2300mm
 - 1200mm x 2300mm
 - 2400mm x 2300mm
 - 2950mm x 2300mm
- Supplied with carry bag
- Standard lead time is 10 – 15 days from artwork approval



Stretch Fabric Arches

- Free artwork set up
- Great for trade shows and exhibitions
- Light weight aluminium frame simply clicks together for easy set up
- Full colour double sided dye sublimation on stretch fabric polyester
- Curved arch available in Eco-Friendly recycled material manufactured to Global Recycled Standard 4.0 (GRS 4.0) and printed with Eco-Friendly inks
- Rectangle Arch sizes:
 - 2970mm x 1000mm x 2300mm
 - 5200mm x 1000mm x 3000mm
- Curved Arch sizes:
 - 2700mm x 1000mm x 600mm x 2300mm
- Supplied with carry bag
- Please contact us for lead time



Exhibition Booths

Portable Trade Show Exhibition Booths

- Free artwork set up
- Great for trade shows, presentations, product launches, back drops etc.
- Light weight aluminium frame and feet (tube frame 1mm thick and 32mm diameter)
- Frame clicks together for quick and easy assembly and dismantle
- Full colour double sided dye sublimation print on 240gsm stretch polyester sleeve
- Stretch polyester Eco-Friendly recycled material manufactured to Global Recycled Standard 4.0 (GRS 4.0) and printed with Eco-Friendly inks
- Various size and shape options available
- Optional accessories available (LED lights, TV stand, S-connect joiner, leg inserts / joiners and table stand)
- Supplied with carry bag
- Standard lead time 10 – 15 days from artwork approval



Exhibition Booth A Includes:

- 1 x 3m stretch fabric display
- 1 x 1m stretch fabric display (flat, angled or curved top)
- 1 x 900mm x 400mm x 850mm promotional table
- 1 x leg connector

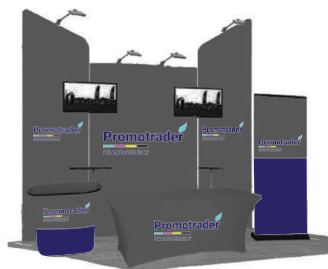

Exhibition Booth B Includes:

- 1 x 3m stretch fabric display
- 2 x 1m stretch fabric displays (flat, angled or curved top)
- 3 x 900mm x 400mm x 850mm promotional table
- 4 x leg connectors



Exhibition Booth C Includes:

- 1 x 6m stretch fabric display
- 2 x 1m stretch fabric displays (flat, angled or curved top)
- 3 x 900mm x 400mm x 850mm promotional table
- 4 x leg connectors

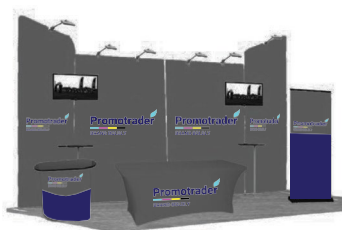

Exhibition Booth D Includes:

- 2 x 3m stretch fabric displays
- 2 x 1m stretch fabric displays (flat, angled or curved top)
- 1 x 900mm x 400mm x 850mm promotional table
- 3 x leg connectors

*Other booth combinations available

Table Covers

Drape or Fitted Table Covers

- Free artwork set up
- Available in drape or fitted style with open or closed back and hemmed edges
- Full colour dye sublimation print on 250gsm knitted polyester
- Eco-Friendly recycled material manufactured to Global Recycled Standard 4.0 (GRS 4.0) and printed with Eco-Friendly inks
- Entire table cover can be printed
- Standard sizes:
 - 1800mm (6 Foot) table top - 1800mm x 700mm with 700mm fall (table cover total size 3200mm x 2100mm)
 - 2400mm (8 Foot) table top - 2400mm x 700mm with 700mm fall (table cover total size 3800mm x 2100mm)
 - Custom sizes available
- Standard lead time 10 - 15 days from artwork approval for orders up to 24 table covers. Please contact us for lead times for orders of 25 or more table covers



Stretch Table Covers

- Free artwork set up
- Full colour dye sublimation print on 200gsm stretch polyester fabric
- Eco-Friendly recycled material manufactured to Global Recycled Standard 4.0 (GRS 4.0) and printed with Eco-Friendly inks
- Entire table cover can be printed
- Available with an open back or closed back (with or without a zip)
- Size options:
 - 1200mm (4 foot) table top - 1230mm x 750mm with 610mm fall
 - 1800mm (6 foot) table top - 1820mm x 750mm with 720mm fall
 - 2400mm (8 foot) table top - 2410mm x 750mm with 720mm fall
- Standard lead time 10 - 15 days from artwork approval for orders up to 24 table covers. Please contact us for lead times for orders of 25 or more table covers



Promotion Tables



Exhibition Tables

- Free artwork set up
- Great for trade shows, exhibitions, presentations etc.
- Full colour digital print on 415gsm PET film
- Quick set up and compact storage
- Black or wood look tabletop
- Light weight frame
- Rear opening to access storage shelf
- Size options:
 - 900mm x 400mm (table top) x 850mm (h), 13kg
 - 1300mm x 400mm (table top) x 890mm (h), 16kg
- Supplied with carry bag
- Standard lead time for quantities up to 4 is 2 – 3 days from artwork approval. Please contact us for lead time for orders of 5 or more

Fabric Covered Tables

- Free artwork set up
- Great for trade shows, exhibitions, presentations etc.
- Entire table cover can be printed
- Dye sublimation print on 250gsm knitted stretch fabric
- Includes light weight frame
- Table size:
 - 800mm x 500mm (table top) x 1000mm (h), 5kg
- Graphic size:
 - 2200mm x 1020mm
- Standard lead time 10 – 15 days from artwork approval



Light Box Counters

- Free artwork set up
- Great for trade shows, exhibitions, presentations etc.
- Easy to assemble light weight aluminium frame – no tools required
- Full colour double sided dye sublimation print on 150gsm polyester
- Bright LED lights used to ensure intense visual effect
- Size:
 - 1000mm x 1030mm
- Supplied with hard shell wheel bag
- Standard lead time is 10 – 15 days from artwork approval



Sampling Tables

- Free artwork set up
- Great for trade shows, exhibitions, presentations etc.
- Full colour digital print on 415gsm PET film
- Light weight, portable and compact storage
- Internal shelf & header board
- Quick and easy assembly - no tools required
- White finish plus print
- Size:
 - 750mm x 470mm (table top) x 800mm (h), 9kg
 - Height including header board, 2000mm
- Standard lead time for quantities up to 4 is 3 - 5 days from artwork approval. Please contact us for lead time for orders of 5 or more

Crowd Barriers

- Free artwork set up
- Great for trade shows, displays, shopping malls, event barriers etc.
- Stainless steel structure with 8kg bases
- Available with velvet ropes or various graphic materials - polyester, vinyl or vinyl mesh
- Graphic size:
 - 1930mm x 850mm
- Standard lead time with polyester banner is 10 – 15 days from artwork approval. Standard lead time with vinyl or vinyl mesh banner is 2 – 3 days from artwork approval for quantities up to 4. Please contact us for lead time for orders of 5 or more



Hanging Corflute Squares

- Free artwork set up
- Great for trade shows, presentations, product launches, displays, shopping malls etc.
- Full colour SAV print on corflute
- Size options:
 - Maximum size 1500mm (square) x 600mm high
 - Custom sizes available
- Large visual area for maximum impact
- Suitable for indoor use
- Standard lead time for quantities up to 4 is 2 – 3 days from artwork approval. Please contact us for lead time for orders of 5 or more

Light Boxes

Polyester Panel Insert Light Box



- Free artwork set up
- Great for trade shows, presentations, displays, shop windows, shopping malls etc.
- Easy to assemble light weight aluminium frame
- Full colour single sided or double sided dye sublimation print on 150gsm polyester
- Bright LED lights used to ensure intense visual effect
- Size options:
 - 992mm x 1984mm
 - 1984mm x 1984mm
 - 2480mm x 1984mm
- Standard lead time 10 – 15 days from artwork approval

Polyester Sleeve Light Box

- Free artwork set up
- Great for trade shows, product displays, conferences etc.
- Light weight aluminium frame clicks together for easy assembly]
- Full colour double sided dye sublimation on 250gsm polyester sleeve
- Eco-Friendly recycled material manufactured to Global Recycled Standard 4.0 (GRS 4.0) and printed with Eco-Friendly inks
- Bright LED lights used to ensure intense visual effect
- Size:
 - 900mm x 2300mm
- Standard lead time is 10 – 15 days from artwork approval



Backlit Poster Frames

- Free artwork set up
- Great for trade shows, presentations, displays, shop windows, shopping malls etc.
- Full colour digital print on 200gsm backlit film
- Portrait or landscape orientation options
- Detachable and adjustable legs (A4 and A3 sizes only)
- Acrylic front - clear
- Light weight unit, 10mm thick (12mm for A1 size)
- Size options:
 - A4 (0.6kg)
 - A3 (1.0kg)
 - A2 (1.9kg)
 - A1 (4.2kg)
- Supplied with transformer
- Standard lead time for quantities up to 4 is 3 - 5 days from artwork approval. Please contact us for lead time for orders of 5 or more



Inflatables

- Free artwork set up
- Full colour dye sublimation print
- Supplied with electric pump for inflation, ropes and pegs for installation and repair patches
- Please contact us for lead times



Inflatable Arch

- Size options:
 - 3000mm x 2850mm
 - 5090mm x 3340mm
 - 7000mm x 5000mm



Inflatable Tent

- Size options:
 - 10 foot: 3000mm x 2400mm
 - 13 foot: 4000mm x 3100mm
 - 16 foot: 5000mm x 3650mm
 - 20 foot: 6000mm x 4400mm

Walls also available

Inflatable Banner or Pillar

- Banner size options:
 - 6 metre
 - 8 metre
 - 10 metre

- Pillar size options:
 - 400mm x 2500mm
 - 670mm x 3000mm



For orders and enquiries, contact us

1300 211 995

www.promotrader.com.au

hello@promotrader.com.au